



Palazzoğlu



TRAILER USER'S MANUAL SINLE AXLE TIPPER SERIE

TYPE :
VIN :
MODEL YEAR :
DATE :

INTRODUCTION

This user manual is an integral part of the trailer you purchased. New and used trailer suppliers must provide in writing that the user manual is handed over with the trailer to the customer.

The information contained herein is valid for the date of publication. As a result of improvement and development efforts, some numerical values and pictures in this manual may not match the actual features of the trailer provided to the end user. The manufacturer reserves the right to make design changes to the trailers without making minor changes to this User's Guide.

This User's Manual, which is an integral part of your trailer, must be carefully read by operators or users before operating, and all recommendations must be obeyed. Thus, the safe operation of the trailer is guaranteed and its problem free usage is ensured. Your trailer is designed to meet mandatory standards, documents and legal regulations in force.

ALL DRIVERS OF THIS TRAILER MUST UNDERSTAND THE CONTENTS OF THE USER'S MANUAL BEFORE COMMENCING WORK.

This user manual describes the basic safety rules and operation of the type of "XXXX" trailer.

If the information in the user manual needs to be clarified, the driver should contact the dealer or the manufacturer where his trailer was purchased for assistance.

Please contact us www.palazoglu.eu/contact - www.palaztrailers.com/contact

The legal obligations of the manufacturer, the warranty and the elements indicating the complete and current regulations are specified in the annex of the warranty.

PALAZOGLU reserves the right to make changes without prior notice and without undertaking the obligations arising from these changes.

We wish you safe and profitable miles! Best regards

PALAZOĞLU TARIM ALETLERİ SAN. VE TİC. LTD. ŞTİ.

Çubuklubala Mahallesi Bayhan Sokak No : 2

İzmit / KOCAELİ – TURKEY

INTEND TO USE OF

The trailer is designed for transport of harvested crops and agricultural products as well as loose and bulk materials in the vicinity of the farm and on public roads at a maximum speed of 40 km/h.

The trailer must not be used in any other purposes than that described above.

Using it as intended also involves all actions connected with the safe usage and proper operation and maintenance.

The trailer is unloaded manually or by placing the load back or on the sides.

The trailer is designed for connection with agricultural tractors of different power ratings, equipped with an external power hydraulic system, an electrical outlet for electrical lighting and warning systems, and a braking system of corrugated tractors and a transporting component.

- Do not use this trailer for the transport of fuel, gas cylinders, environmentally hazardous substances and similar loads due to the compatibility requirements for the carriage of hazardous materials. The manufacturer cannot be held responsible for any damages that occurs, as such transports will only be carried out by the user.
- The trailer must only be used by people who have read the instruction manual and have received training on danger and first aid for victims of accident.
- Comply with all applicable laws for accident prevention and all other accepted rules on engineering safety, occupational health and traffic safety.
- The manufacturer cannot be held responsible for any damages resulting from any unauthorized modifications to the design of this trailer.



THE TRAILER IS NOT DESIGNED FOR TRANSPORTING OF PEOPLE.

BASIC EQUIPMENTS

The basic equipment of each trailer includes:

- Instructions for Use's guide;
- Warranty certificate with warranty conditions;
- Bracket for the "slow-moving vehicle" sign;
- Two-line pneumatic brakes with adjustable braking force (optionally, single system and hydraulic system are available);
- Parking brake;
- Lighting installation;
- Pneumatic/Spring suspension system.

Up on the customer request (and for an additional fee), the manufacturer can equip the trailer with a slow- moving vehicle sign and a reflective warning triangle.

VEHICLE IDENTITY (VIN No.)

Vehicle consisting of 17 characters and starting with the world manufacturer code (WMI) Chassis No. written by punching or engraving on the chassis arm in the right front corner of the trailer.

Trailer is tracked with Chassis No during the usage.

The Type Label is mounted on the right front-bottom corner of the trailer with rivets or by sticking.

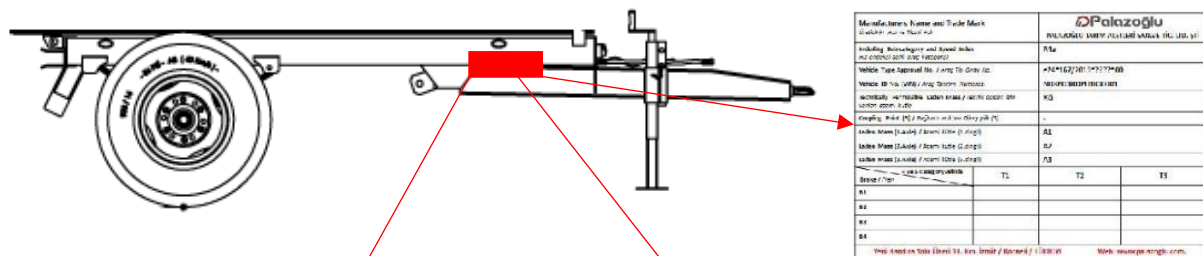

VIN Attachment Region
Methods of attachment of VIN: hammering, punching, etching or laser engraving

Statutory Plate Attachment Region Methods of attachment of Statutory Plate: Riveting or clinching. Vehicle identification number consist of 17 characters.

SYMBOLS AND DESCRIPTIONS



CAUTION!

A safety instruction follows this symbol. Failure to follow this instruction correctly may result in damage to your trailer, injury, and in some cases death.



INFO!

It symbolizes that it is connected with another information. For example, a link to another document or a useful tip.



WARNING!

It symbolizes the in case of malfunctions.



IMPORTANT!!

It symbolizes the need for maintenance, repair and / or cleaning.

Qualified persons who perform the required tasks by always using their education, experience and training, as well as their understanding of standards, definitions, accident prevention regulations and operating conditions; hence they are also capable of identifying and avoiding potential hazards.

Among others, these persons are also required to understand first aid measures for the injured (e.g. by wounding).

The term **"Operation"** includes settings, starting (preparation for use) and operation (starting, commissioning, powering off, etc.).

The term **"Maintenance of Proper Condition"** includes checks and care (control, adjustments), servicing and repairs (troubleshooting).

Note all other (specially highlighted) indications for transport, assembly, operation, servicing and technical data (in the operating instructions, production records and on the trailer itself). It is all the same essential due to the potential (direct and indirect) hazards and their consequences being severe damage of human health and property.

OBLIGATORY NOTIFICATION

When the trailer is transferred to another user, the Operating Instructions shall be transferred as well, whereas the receiving user must undergo training according to the instructions.

GENERAL SAFETY REGULATIONS OF WORK AND USE



Read this chapter carefully prior to using of the trailer. Always apply the following points of attention in the daily use of the trailer!

Before each start of work, inspect the trailer for work safety.

- ❖ Aside from the guidelines in these Operating Instructions, follow the general regulations for safety and accident prevention.
- ❖ The affixed information and warning signs and text indicate important guidance for safe operation. Follow for your own safety.
- ❖ Start the trailer only when all required equipment is connected and secured (the hitch and tow bar system, couplings, etc.).
- ❖ Understand all equipment and controls, as well as their functions, before work. It is too late to learn that during work.

The trailer must not be used by persons who are under the influence of alcohol and/or other substances, and/or not trained or suitably licensed to operate motor vehicles.

BEFORE THE FIRST USE

The manufacturer guarantees that the trailer is fully operational and has been checked according to quality control procedures and is ready for normal use. This does not release the user from an obligation to check the machine's condition after delivery and before first use. The machine is delivered to the user completely assembled.

Before commencing work, machine operator must inspect the technical condition of the trailer and prepare it for the first start-up. The user must carefully read this Operator's Manual and observe all recommendations, understand the design and the principle of machine operation.



Before hitching to tractor and using the trailer, the user must carefully read this Operator's manual and observe all recommendations

- Check completeness of machine (standard and optional equipment).
- Check condition of protective paint coat,
- Inspect trailer's individual components for mechanical damage resulting from
- incorrect transport (dents, piercing, bent or broken components).
- Check technical condition of tyres and tyre pressure.
- Check technical condition of elastic hydraulic conduits.
- Check technical condition of pneumatic conduits.
- Check that there are no hydraulic oil leaks.
- Check electric lamps.
- Check tipping ram cylinder for hydraulic oil leaks.
- Check all the trailer's lubrication points, lubricate the machine as needed.
- Check if the nuts and bolts fixing the wheels are properly tightened.
- Drain air tank of the braking system.
- Ensure that pneumatic, hydraulic and electric connections in agricultural tractor are according to the requirements, if not the trailer should not be hitched to the tractor.

If all the above checks have been performed and there is no doubt as to the trailer's good technical condition, it can be connected to tractor. Start the tractor, check all systems and conduct test run of trailer without load (no load in load box). It is recommended that the inspection is conducted by two people, one of which should always remain in the tractor cab. Test drive should be conducted according to the sequence shown below.

- Connect the trailer to appropriate hitch on agricultural tractor.
- Connect conduits of braking, electrical and hydraulic systems.
- Switch on individual lights, check correct operation of electrical system.
- Check hydraulic system if it work properly
- When moving off check if the main brakes operate correctly.
- Perform test drive.

COUPLING OF TRAILER TO TRACTOR

! Risk of injuring your hand when coupling the trailer to the tractor!

- To couple the trailer to the tractor, do the following:
- Move the tractor in front of the trailer,
- Remove the safety from the hitch pin and then remove the pin, the hitch axis and trailer towing eye axis must be aligned.
- When the tow eye is positioned in the hitch, insert the safety pin and secure it.
- Connect the electrical, hydraulic and pneumatic connections of the trailer.
- Check all the functions of the trailer before moving.
- Take the wheel wedge away.
- Release the trailer parking brake.
- The trailer is ready to be towed.

DECOUPLING OF TRAILER FROM TRACTOR

! When removing the trailer from the tractor, make sure that the trailer is secured with chocks!

- Do the following actions to decouple the trailer from the tractor;
- Stop the tractor with the trailer and engage the tractor parking brake;
- Engage the trailer's parking brake;
- If the trailer stands on an uneven or sloping ground, secure it against rolling down by chocking the wheels; Disconnect the electrical, hydraulic and pneumatic lines from the tractor
- Remove the safety from the hitch pin and then remove the pin – this will decouple the tow bar from the hitch. Drive away with the tractor and reinstall the pin in the hitch.

! Do not decouple the trailer from the tractor in the following cases:
Hydraulic damper body is lifted;
Trailer is not secured against rolling away.

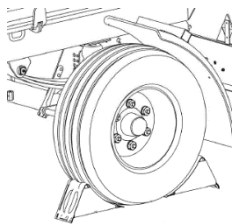

Method of placing chocks

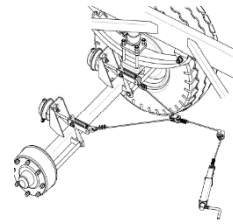

Parking brake

LOADING

Before beginning loading make certain that the load box side walls and slide gate are properly closed and secured. The trailer must be positioned to travel forwards and be hitched to the tractor. Loading should only take place, when trailer is placed on flat level surface and hitched to tractor. If the trailer is equipped with tarpaulin cover, it should be rolled.

Regardless of the type of load carried, the user is obliged to secure it in such a manner that the load is unable to spread and cause contamination of the road. If this is impossible, do NOT transport this type of load.

Materials, which in contact with painted or steel surfaces may cause damage, should be transported in sealed packaging (bags, boxes, barrels, etc.). After unloading, the load box should be thoroughly cleaned with a strong jet of water.

If the transported materials exert high local pressure on the load box platform it should be protected against damage using thick planks, plywood or other materials of similar properties.



Do NOT exceed the trailer's maximum carrying capacity.

Bulk materials

Loading bulk materials is normally conducted with the use of loaders or conveyors and possibly loading manually. Do not load bulk materials to a height greater than that of side walls or extensions. On completion of loading, the load should be evenly spread over the whole surface of the load box.

Solid lumps

Loads of pieces or solid lumps are generally hard materials of significantly greater dimensions than bulk loads (stones, coal, bricks and ballast). These materials without prior preparation of the load box may cause indentation of the floor or walls and abrasion of paintwork. In order to protect it, lay thick plywood, hard particle board, thick planks or other materials of similar properties on the load box platform and possibly on walls and Wall extensions. Non-compliance with the instructions provided could invalidate the guarantee. Loading of material in pieces or solid lumps must be from a low height. The load must not fall with great force on the floor of the load box, even if it is protected.

Hazardous loads

According to the European ADR agreement concerning the international road transport of hazardous materials, the transport of this type of load (defined in detailed by this agreement) is prohibited with the use of agricultural trailers.

High volume loads

High volume loads (light with large volumes) such as hay, presses blocks or bales, straw, silage etc. should be loaded with appropriate fittings: bale grabs, forks etc. Load may be loaded even exceeding the height of load box extensions but particular attention should be paid to the trailer stability and the proper attachment and securing of the load. Remember that higher loading has a negative effect on trailer stability.

UNLOADING

The trailer is equipped with hydraulic tipping system and suitable frame structure and the load box allowing tipping sideways and to the rear. Tipping of the load box is controlled from driver's cab using external tractor hydraulic system manifold.



BEFORE OPERATION

- All work safety information shall be given to all other users of the trailer.
- Check the direct environment (for children and bystanders) before start. Pay particular attention when visibility is poor.
- After unloading the trailer, lower the load body completely. Never leave the trailer unattended with its load body raised.
- Do not remain on the trailer in motion, while coupling the trailer with a tractor and loading or unloading the trailer.
- After unloading the trailer, lower the load body completely. Never leave the trailer unattended with its load body raised.
- Do not let somebody to remain within the range of a load being discharged.
- Start the hydraulic lift (tipping) of the load body only when;
 - the trailer is coupled with a tractor, AND
 - the trailer is parked on a hard and level ground, AND
 - no persons in the unloading area, AND
 - when the tractor's axis is aligned with the trailer, AND
 - when the machines are at a safe distance from all power lines, AND
 - there are no strong gusts of wind.
 - When you are sure that sidewalls are opened

If it is necessary to unload to the rear while parking on a slope, the trailer with the tractor must be parked in the uphill direction.

If unloading to the side on a slope, tilt the load body to the side opposite to the trailer's direction of gradient.

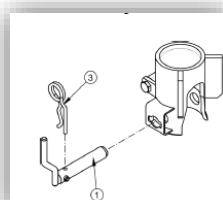

Tipping pins



PINS

Trailer has 4 tipping pins. Position tipping pins (connecting load box with the lower frame) on the unloading side and properly secure with a cotter pin.

Tipping pins and individual sockets are designed so it is impossible to place them on the opposite diagonal side of the load box, which would damage the trailer.

- Remove the safety pin that couples the load body with the chassis frame
- Unloading to the back – the pins must remain in the rear bells of the load body
- Unloading to the left – the pins must be installed in the left hand bells
- Unloading to the right – the pins must be installed in the right hand bells
- Make sure that the pins on the side to which the trailer is to be unloaded have been properly installed

SIDEWALLS



Trailer sidewalls should be opened before lifting body. Tipping side walls must be unlocked with lever.

Trailer has central locking system . All lockers will be opened when operator lift up leveler

TIPPING

- Tip the load body by operating the hydraulic actuator.
- After the load has been discharged, lower the body and secure the box with the locks.

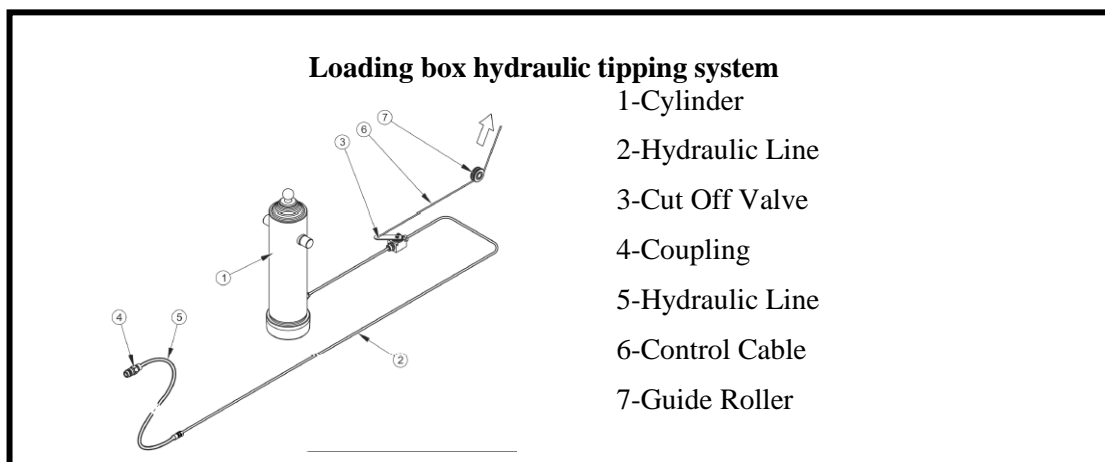

TRANSPORT

- Before driving, check that the trailer lighting is working and that the trailer identification is complete.
- Follow the traffic code regulations when travelling on public roads.
- Exceeding the permissible payload and driving speed may damage the trailer and compromise traffic safety.
- Do not exceed the driving speed of regulated capacity.
- The trailer is designed for operation at a maximum grade of 8°.
- When travelling on public roads, the trailer must feature a reflective warning triangle, and the slow-moving vehicle sign in the trailer bracket located on the chassis frame rear crosspiece (included with the trailer).
- Do not leave the loaded trailer on slopes and when it is not secured against rolling. Secure the trailer by engaging the parking brake and chocking the wheels. Also bind the transported load with transport straps.
- Speed must be sufficiently reduced before making a turn or driving on an uneven road or a slope.
- When driving, avoid sharp turns especially on slopes.
- Please note that the braking distance of the tractor and trailer combination is substantially increased at higher speeds and loads.
- Monitor trailer's behaviour when travelling on an uneven terrain, and adjust driving speed to road conditions, slow down early enough when turning.

PROPER USE AND MAINTENANCE OF WHEELS

- When working on the tyres, chocks or other objects without sharp edges should be placed under the wheels of the trailer to prevent it from rolling. Wheels can be taken off the trailer axle only when the trailer is not loaded.
- Repair work on the wheels or tyres should be carried out by persons trained and entitled to do so. This work should be carried out using appropriate tools.
- Inspect tightness of nuts after the first use of trailer, after the first travel under load and then every 6 months of use or every 25,000 km. In the event of intensive work, check the nut tightening at least every 100 km. The inspection should be repeated individually if a wheel has been removed from the wheel axle.
- Regularly check and maintain correct air pressure in tyres according to Operator's Manual (especially if trailer is not used for a longer period).
- Air pressure in tyres should be also checked during the whole day of intensive work. Please note that higher temperatures could raise tyre pressure by as much as 1 bar. At high temperatures and pressure, reduce load or speed.
- Do not release air from warm tyres to adjust the pressure or the tyres will be underinflated when temperatures return to normal.
- Tyre valves should be protected with caps to avoid soiling.
- Do not exceed the trailer's maximum design speed.
- When sweeper is operated all day, stop working for a minimum of one hour in the afternoon.
- Take a 30 minute-break for cooling tyres after driving 75 km or after 150 minutes of continuous travel, depending on which occurs first.
- Avoid potholes, sudden manoeuvres or high speeds when turning.

PERIODIC CONTROLS FOR PROPER USE

BRAKE SHOE LININGS

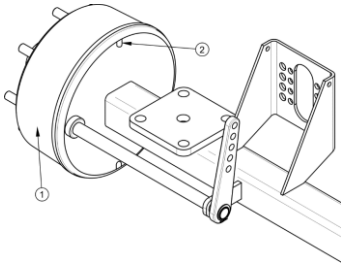

Check brake shoe linings for wear:

- every 3 months,
- if brakes overheat,
- if brake cylinder piston stroke is significantly longer,
- if there are unusual noises from the drum of wheel axle.

Minimum thickness of brake shoe linings is 2 mm.



After purchasing trailer, the user is responsible for general checking of brake system of trailer axles.



Initial inspection of axle brakes must be conducted after first use and after first travel with load

Inspection procedures

- Hitch trailer to tractor and place chocks under rear trailer wheel.
- Engage and release in turn the main brake and then the trailer parking brake.
- Check fixing of cylinder and return springs.
- Check cylinder movement and correct return of piston to start position.
- Check if axle elements are in place, (cotter pins in castellated nuts, expansion rings etc.).
- Check hydraulic cylinders or pneumatic cylinders for tightness.

AXLE BEARINGS FOR SLACKNESS

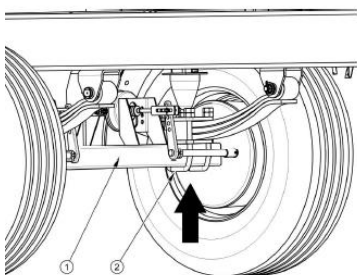

- Hitch trailer to tractor, immobilize tractor with parking brake.
- Park tractor and trailer on hard level ground
- Place chocks under trailer rear wheel. Ensure that trailer shall not move during inspection.
- Raise the wheel (opposite to the side where chocks are placed).
- Turning the wheel slowly in both directions check that movement is smooth and that the wheel rotates without excessive resistance.
- Turn the wheel so that it rotates very quickly, check that the bearing does not make any unusual sounds.
- Moving the wheel try to detect slackness.

If slackness is felt, adjust bearings. Unusual sounds coming from bearing may be symptoms of excessive wear, dirt or damage. In such an event the bearing, together with sealing ring, should be replaced with new parts, or cleaned and greased again. During inspection of bearings ensure that possibly detected slackness comes from the bearing and not from the suspension system (e.g. slackness of leaf spring pins etc.).



Check wheel axle bearings for slackness after travelling the first 1 km, after intensive use of trailer, Every six months of use or every 25,000 km

NUT TIGHTENING

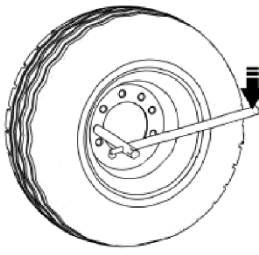

Checking the wheel nut tightening

- after first use
- after first travel with load
- after travelling the first 1,000 km
- every six months of use or every 25,000 km



Wheel nuts must not be tightened with impact wrench because of danger of exceeding permissible tightening torque the consequence of which may be breaking the connection thread or breaking off the hub pin.



The greatest precision is achieved using a torque spanner. Before commencing work, ensure that correct tightening torque value is set.

AIR TANK

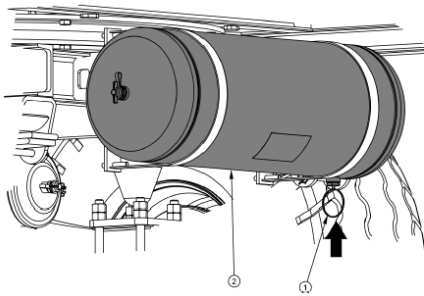

- Open drain valve (1) placed in lower part of tank (2) - tank is placed in rear part of turntable frame
 - The compressed air in the tank causes the removal of water to the exterior.
- Released valve stem should automatically close and stop flow of air from the tank.
 - If the valve stem resists returning to its position, then the whole drain valve must be unscrewed and cleaned or replaced

- Completely reduce pressure in air tank.
- Unscrew valve.
- Clean the valve, blow it with compressed air.
- Screw in valve, fill tank with air and check tank tightness.



Draining water from air tank after each week of use.



Release air from the air tank before dismantling drain valve

HYDRAULIC SYSTEM

- Hitch trailer to tractor.
- Connect all hydraulic system conduits according to maintenance instructions.
- Clean connections and cylinders (tipping cylinder and possibly hydraulic brake cylinders).
- Conduct test tipping of load box sideways and backwards.
- Press tractor brake pedal several times.
 - If trailer is equipped with hydraulic brake system.
- Check hydraulic cylinders and conduits for tightness.
- If leaks appear at connections then tighten the connections.

If oil leak is detected on hydraulic cylinder body, ascertain origin of leak. Inspect seals when hydraulic cylinder is completely extended. Minimum leaks are permissible with symptoms of "sweating", however in the event of noticing leaks in the form of "droplets" stop using the trailer until faults are remedied. If unreliability is evident in brake cylinders, do NOT use trailer with damaged system until faults are remedied.



Checking tightness after the first week of use and every 12 months of use.

AXLE PLATE NUTS (SPRING HOLDER)

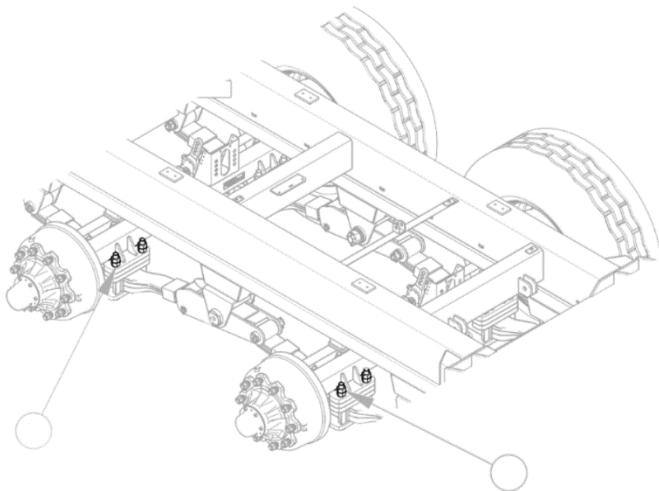

Checking the axle plate nut tightening

- after first use
- after first travel with load
- after travelling the first 1,000 km
- every six months of use or every 25,000 km

Brakes

MAIN BRAKE

The trailer is equipped with one of four types of main brake

- double conduit pneumatic system
- single conduit pneumatic system
- hydraulic brake system

The main brake (pneumatic or hydraulic brake) is activated from the tractor driver's cab by depressing the brake pedal. The function of the control valve (2), is to activate the trailer's brakes simultaneously with the tractor's brakes. Furthermore, in case of an inadvertent disconnection of the conduit between the trailer and the tractor, the control valve will automatically activate the trailer's brakes. The valve is equipped with a brake applying button to be used when the trailer is disconnected from the tractor. When compressed air conduit is connected to the tractor, the device automatically applying the brakes changes its position to allow normal brake operation.

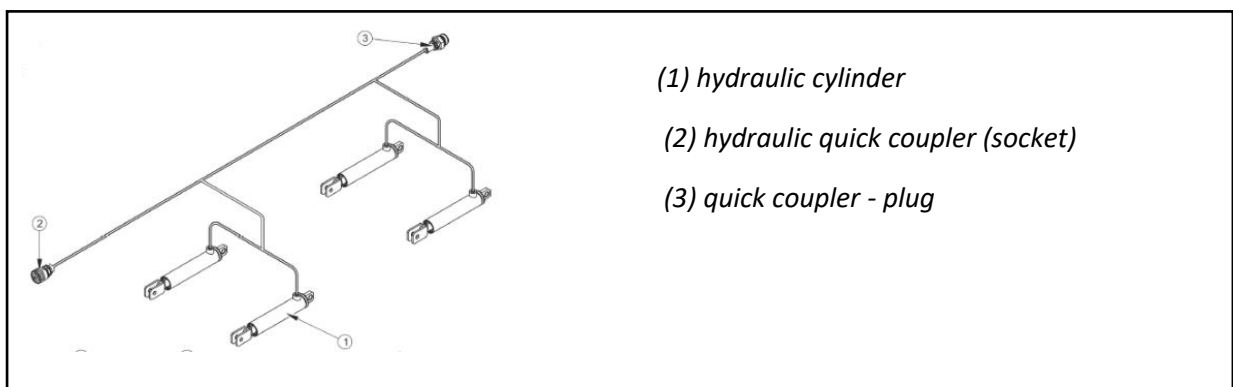
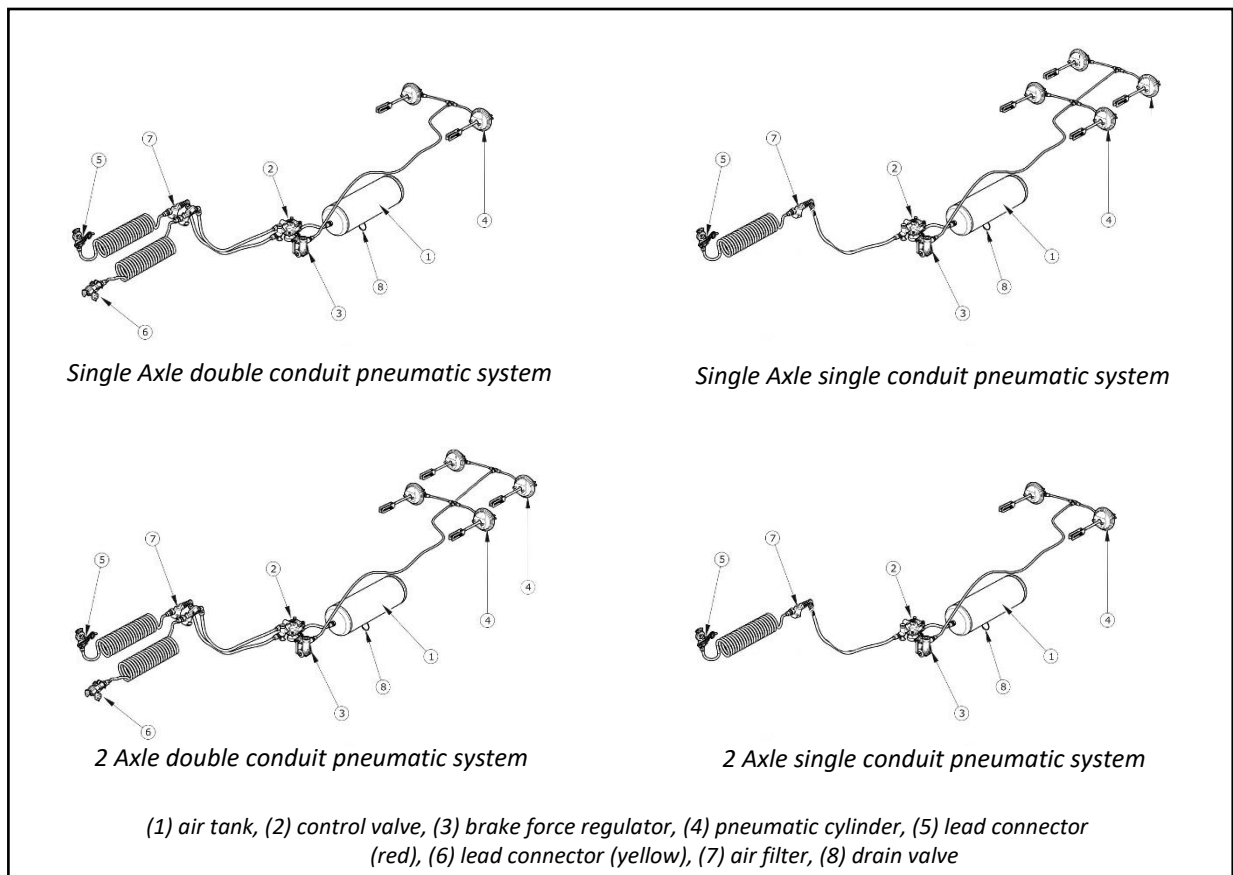

Hydraulic Brake System

PARKING BRAKE

The parking brake is for immobilising product while standing motionless. Brake crank mechanism body (1) is welded to the left longitudinal member of the lower frame. Steel cable (3), routed through two guide rollers (4), is connected with expanded levers of axle (2) by crank mechanism. Tightening the cable (turning the crank lockwise) causes tilting of the expander lever, which parts the jaws of the brake shoes immobilising the slurry product.

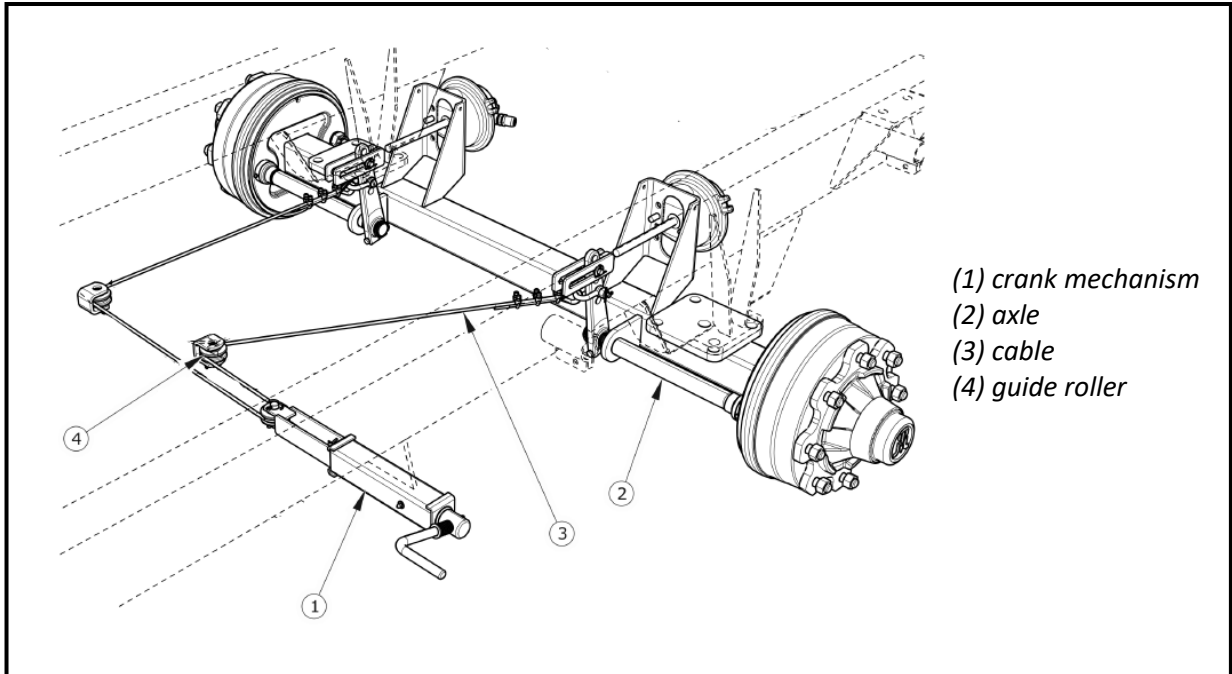

Brake Adjustment

When servicing the trailer, check the condition and connections of the braking system, and periodically inspect the lubrication of control elements.

Adjust the brakes when the following occurs:

- There is an excessive clearance between the shoes and the drum wear, resulting in decreased braking performance;
- Brakes work unevenly and out of sync.

With the properly adjusted brakes, the braking force (i.e. the total of braking forces at the circumference of the wheels) shall be at least 25% of the permissible total weight of the trailer when decelerating with the service brake;

(The minimum legal requirement for trailer brakes on the highway is 25% braking efficiency at a maximum speed of 20 mph (32kph). On trailers above this speed (dual-circuit hydraulic or air braking) braking performance should have 45% braking efficiency).

The braking force (i.e. the total of braking forces at the circumference of the wheels) when actuating the parking brake shall be at least 16% of the permissible total weight of the trailer.

Both wheels on the same axle should be stopped evenly; the brake force differential between the left and right trailer side shall not exceed 30%.

Park the trailer so that the rear wheels turn freely. Remove the segment (3) so that the lever (1) can move freely against the shaft (2) so that the brake shoes can rub gently against the brake drum while turning the wheel freely.

After the correct adjustment of friction components, the wheel should rotate smoothly, without cogging or evident resistance (other than caused by rubbing of the brake shoes to the drum). It is normal for the shoes to slightly rub against the drum, especially on a brand new trailer or after changing the brake shoes.

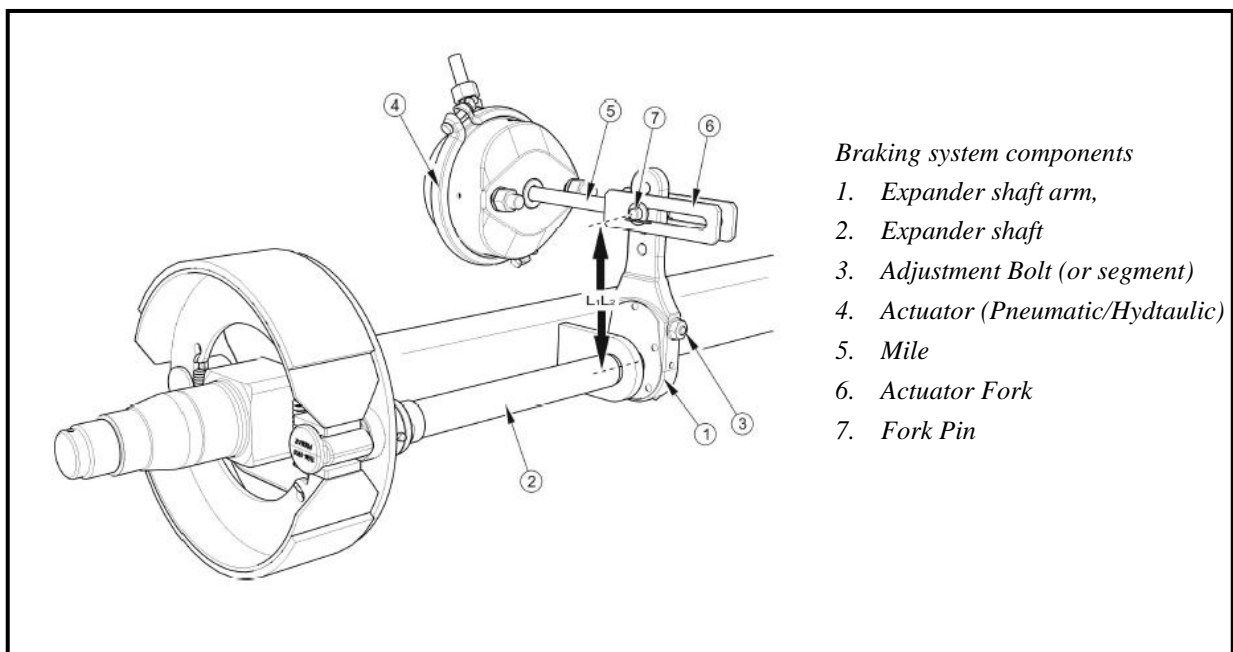

Before driving, periodically inspect all braking components for proper operation, tightness and clearance. Adjust or repair as necessary.

OBLIGATORY NOTIFICATION

When the trailer is transferred to another user, the Operating Instructions shall be transferred as well, whereas the receiving user must undergo training according to the instructions.

GENERAL SAFETY REGULATIONS OF WORK AND USE



Read this chapter carefully prior to using of the trailer. Always apply the following points of attention in the daily use of the trailer!

- ❖ Aside from the guidelines in these Operating Instructions, follow the general regulations for safety and accident prevention.
- ❖ The affixed information and warning signs and text indicate important guidance for safe operation. Follow for your own safety.
- ❖ Start the trailer only when all required equipment is connected and secured (the hitch and tow bar system, couplings, etc.).
- ❖ Understand all equipment and controls, as well as their functions, before work. It is too late to learn that during work.

The trailer must not be used by persons who are under the influence of alcohol and/or other substances, and/or not trained or suitably licensed to operate motor vehicles.

TRAVELLING ON PUBLIC ROADS







Before driving, check that the trailer lighting is working and that the trailer identification is complete.



Follow the traffic code regulations when travelling on public roads.

1. Exceeding the permissible payload and driving speed may damage the trailer and compromise traffic safety.
2. Do not exceed the driving speed of regulated speed.
3. The trailer is designed for operation at a maximum grade of 8°.
4. When travelling on public roads, the trailer must feature a reflective warning triangle, and the slow-moving vehicle sign in the trailer bracket located on the chassis frame rear crosspiece (included with the trailer).
5. Do not leave the loaded trailer on slopes and when it is not secured against rolling. Secure the trailer by engaging the parking brake and chocking the wheels. Also bind the transported load with transport straps.

WARNING/INFORMATION SIGNS AND LABELS OF TRAILER

The warning signs and labels on the trailer must not be removed. They are intended for safe handling of the trailer. If any information label is damaged or removed, order a spare one. Text and symbol label stickers are available from service agents or the trailer's manufacturer.

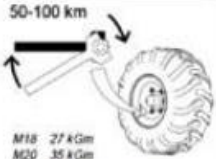
1	WARNING! CAUTION!	
2	DANGER OF FALLING!	
3	DANGER OF COLLISION WHEN TURNING!	
4	DANGER OF MOVEMENT!	
5	KEEP A DISTANCE FROM POWER LINE!	
6	DANGER OF HAND INJURY!	
7	READ THE MANUAL!	
8	DO NOT RIDE ON OR IN FRONT OF THE TRAILER!	
9	DANGER AT TURNING!	
10	KEEP DISTANCE!	
11	USE TYRE WEDGE!	
12	LUBRICATE PERIODICALLY!	

13	JACKING/LIFTING POINT!	
14	CHECK THE TIGHTNESS OF THE WHEEL NUTS!	<p>50-100 km</p>  <p>M18 27 kGm M20 35 kGm M22 45 kGm</p>
15	REMOVE IGNITION KEY BEFORE SERVICING!	
16		  
17		  
18		  

STORAGE

Protect the trailer against direct exposure to sunlight and rain. Park it with its land wheels chocked on a hard-paved ground (reduce tyre pressure and cover the tyres if there is a risk of exposure to sunlight).

If the trailer is exposed to weather, periodically check for rainwater accumulation in the trailer. Note all damage to the paint coat. Clean and degrease spots of damaged paint. Next, repaint with the same colour and coat thickness.

Long-term storage is allowed in sheltered rooms only.

SALE

- The buyer collects the trailer from the manufacturer or the sales representative on their own, or arranges the delivery with the manufacturer.
- The trailer is sold as fully assembled and ready for operation, complete with the basic equipment listed in Section 1.2 of this manual. Optional equipment is available for extra charge.
- The sales representative personnel is required to introduce the buyer to the design and operation of the trailer, along with safety requirements and warranty conditions.
- The buyer shall verify the following:
 - The trailer is complete, undamaged and with all essential equipment;
 - The nameplate located on the chassis front cross-piece has the serial number stamped that matches the data in the warranty card;

The warranty card has been properly filled out with the identification data on the nameplate

DESCRIPTION OF RESIDUAL RISKS

PALAZOĞLU is liable for the design and build in order to eliminate all hazards, some partial risk is unavoidable in operation of the trailer.

The residual risk stems mostly from improper behaviour of the operator caused by lack of knowledge or attention.

Avoid the following dangerous and prohibited actions:

- Trailer should not be used by unauthorized persons or persons who do not have a license to use a tractor or do not know the instructions for use..
- Trailer cannot be used by people who are alcoholic or other intoxicating or under the influence of drugs.
- Trailer cannot be used for different purposes other than specified in the manual.
- No one should be between the tractor and trailer while the tractor engine is running.
- Surrounding viewers, especially children, should not be located near the working trailer.
- The trailer is not cleaned while working.
- Avoid manipulations caused by the drive units on the tractor or the moving elements of the trailer..
- Do not check the technical condition while the trailer is running.

RESIDUAL RISK ASSESSMENT

Residual risks arise when the prescribed rules and indications are not obeyed!

Follow these below guidelines:

1. Always follow the safety instructions described in the user manual.
2. Read the user manual and understand it completely.
3. Keep your hands away from dangerous areas.
4. It is forbidden to operate the trailer in the presence of bystanders, this applies in particular to children.
5. Maintenance and repairs of the trailer shall only be performed by trained personnel.
6. The trailer shall only be operated by persons who have been trained and have familiarised themselves with the Operating Instructions.
7. The trailer is protected against access by children.

Only then can you eliminate the residual risks to people and the environment when using this trailer.



Palazođlu Tarım Aletleri San. Ve Tic. Ltd. Şti.

İzmit / KOCAELİ - TURKEY

tel.: +90 262 361 60 82 +90 262 361 63 04
 +90 262 361 62 59 +90 533 235 0970
fax: +90 262 361 62 96

www.palaztrailers.com

Read the trailer thoroughly before use!

Keep the trailer longer usage life!